



Air handling units

Centrales de traitement d'air simple flux

Lüftungsgeräte

Приточные агрегаты



- Low noise level.
- Fans: ~1f with external rotor motor.
- Adjustable voltage fan control.
- Electrical heater.
- Easily removable inspection cover.
- Filter box with an G3-class panel filter.
- Wall insulation is 50mm.

Air supply units for ventilation systems. Not designed for functioning in explosive – inclined areas. The unit is designed for the air supply into premises. It consists of a duct fan, a duct air heater and a filter box. All these elements are installed in an isolated housing. The thickness of the wall insulation is 50 mm. The housing is made of galvanized steel and has an easily removable cover. The cover is attached by four hinges which are easy to unclasp.



- Niedriges Geräuschniveau.
- Ventilator mit Geschwindigkeitsregelung (Spannungsänderung).
- Elektrische Erwärmungseinrichtung.
- Leicht abnehmbarer Deckel für Wartung.
- Filterkasten mit dem Filter der G3-Klasse.

Das Zuluft-Aggregat ist für Luftlieferung in Räumlichkeiten bestimmt. Es besteht aus einem Kanalventilator, einer Kanal-Luft erwärmungseinrichtung und einem Filterkasten. Alle diese Elemente sind im isolierten Gehäuse montiert. Isolationsdicke 50 mm. Das Gehäuse ist aus verzinktem Blech mit leicht abnehmbarem Deckel hergestellt. Der Deckel wird mit vier leicht aufknöpfbaren Scharnieren befestigt.



- Faible niveau de bruit.
- Ventilateur à vitesse réglée (changement d'intensité).
- Batterie électrique.
- Ouverture facile du panneau.
- Cassette de filtres avec filtre de classe G3.

Les unités sont destinées à l'apport d'air dans les locaux. Elles se composent d'un ventilateur pour gaine, d'une batterie électrique et d'une cassette de filtres. Tous ces éléments sont montés dans une enveloppe isolée. Épaisseur de l'isolation 50 mm. L'enveloppe est réalisée à partir de tôle galvanisée le panneau s'ouvre facilement. Le panneau est consolidé par quatre charnières facilement détachables.



- Низкий уровень шума.
- Вентилятор с регулировкой скорости (изменение напряжения).
- Электрический нагреватель.
- Легко снимаемая крышка для проверки.
- Кассета фильтров с фильтром класса G3.

Агрегат подачи воздуха предназначен для подачи воздуха в помещения. Он состоит из канального вентилятора, канального нагревателя воздуха и кассеты фильтров. Все эти элементы установлены в изолированном корпусе. Толщина изоляции 50 мм. Корпус изготовлен из оцинкованной жести с легко снимаемой крышкой. Крышка крепится легко отстегивающимися шарнирами.

## Accessories

Single phase speed controller  TGRV p. 191	Monophase speed controller  MTY p. 193	Controller for electrical heater  EKR 15.1 p. 188	Controller for electrical heater  EKR 6.1 p. 190	Mounting clamp  AP p. 197	Back draft shutter  RSK p. 195
---	---	--	---	--	---

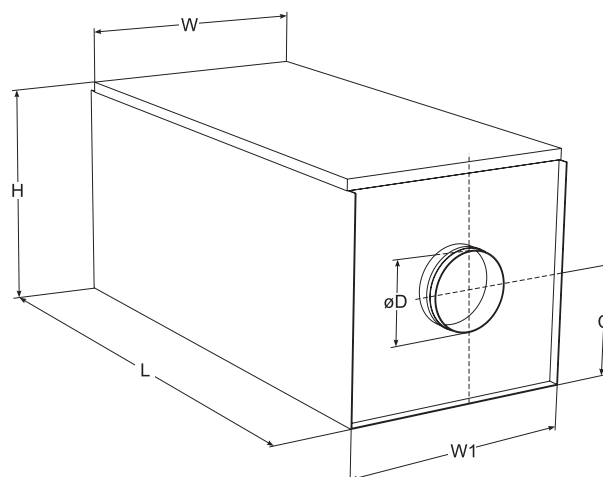

Type	Dimensions [mm]					
	W	W1	C	L	H	øD
OTA 125	490	485	236	1000	490	125
OTA 160	490	485	236	1000	490	160
OTA 200	490	485	236	1000	490	200
OTA 250	550	545	285	1050	585	250
OTA 315	550	545	285	1050	585	315

Type	Accessories							
	TGRV	MTY	EKR 15.1	EKR 6.1	AP	RSK	AKS	TJK 10K
OTA 125/1200	1	0,5	-	+	125	125	125	+
OTA 160/2000	1	1,5	-	+	160	160	160	+
OTA 160/2400	1	1,5	-	+	160	160	160	+
OTA 160/5000	1	1,5	-	+	160	160	160	+
OTA 160/6000	1	1,5	-	+	160	160	160	+
OTA 200/2000	1	1,5	-	+	200	200	200	+
OTA 200/2400	1	1,5	-	+	200	200	200	+
OTA 200/3000	1	1,5	-	+	200	200	200	+
OTA 200/5000	1	1,5	-	+	200	200	200	+
OTA 200/6000	1	1,5	-	+	200	200	200	+
OTA 250/1200	1	1,5	-	+	250	250	250	+
OTA 250/5000	1	1,5	-	+	250	250	250	+
OTA 250/6000	1	1,5	-	+	250	250	250	+
OTA 250/9000	1	1,5	+	-	250	250	250	+
OTA 315/5000	2	2,5	-	+	315	315	315	+
OTA 315/6000	2	2,5	-	+	315	315	315	+
OTA 315/9000	2	2,5	+	-	315	315	315	+

## Accessories

Circular duct silencer



AKS

p. 198

Duct sensor



TJK 10K

p. 162

# OTA

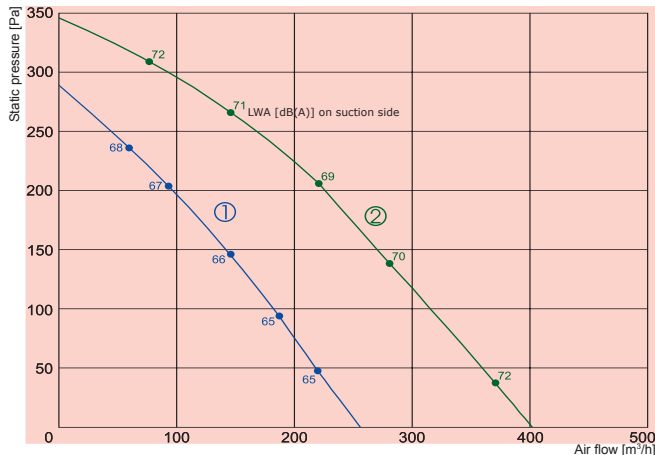

① — OTA 125  
② — OTA 160

		125/1200	160/2000	160/2400	160/5000	160/6000
Heater	-phase/voltage [50Hz/VAC]	~1, 230	~1, 230	~1, 230	~2, 400	~2, 400
	-power consumption [kW]	1,2	2,0	2,4	5,0	6,0
	-min. air speed [m/s]	1,5	1,5	1,5	1,5	1,5
Fan	-phase/voltage [50Hz/VAC]	~1, 230	~1, 230	~1, 230	~1, 230	~1, 230
	-current [A]	0,26	0,41	0,41	0,41	0,41
	-speed [min <sup>-1</sup> ]	2549	2621	2621	2621	2621
	-power consumption [W]	60	95	95	95	95
	-max. airflow [m³/h]	256	402	402	402	402
-motor protection class		IP-44	IP-44	IP-44	IP-44	IP-44
Terminal box protection class		IP-54	IP-54	IP-54	IP-54	IP-54
Filter class		G3	G3	G3	G3	G3
Total sound pressure level at 1 m [dBA]		58	63	63	63	63
Wiring diagram		No. 1	No. 1	No. 1	No. 2	No. 2
Weight [kg]		37,0	39,0	39,0	39,0	39,0

## 125/1200

	Lpa dB(A)	Lwa total dB(A)	Lwa, dB(A)								
			63 Hz	125 Hz	250 Hz	500 Hz	1 kHz	2 kHz	4 kHz	8 kHz	16 kHz
Inlet	58	65	25	38	59	58	60	59	52	42	27
Outlet	56	63	28	38	57	55	58	56	46	38	24
Casing break out	42	49	13	23	42	41	42	41	35	27	13

Measured at 202 m³/h, 72 Pa

## 160/5000

	Lpa dB(A)	Lwa total dB(A)	Lwa, dB(A)								
			63 Hz	125 Hz	250 Hz	500 Hz	1 kHz	2 kHz	4 kHz	8 kHz	16 kHz
Inlet	63	70	32	43	65	60	65	63	57	43	26
Outlet	63	70	32	47	63	64	64	61	55	44	30
Casing break out	47	54	19	28	48	43	47	45	40	28	12

Measured at 281 m³/h, 138 Pa

The unit characteristic curves were determined in accordance with DIN 24163 resp. ISO 5801. The sound levels were determined in accordance with DIN 45635 resp. ISO 3744 at a distance of 1 m from the unit.

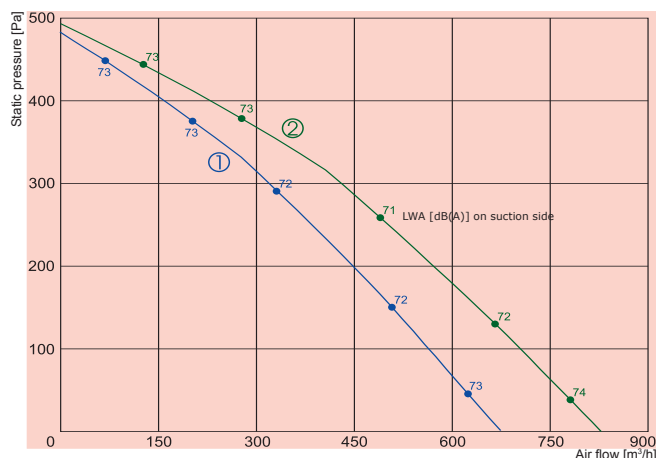

① OTA 200  
② OTA 250

		200/2000	200/2400	200/3000	200/5000	200/6000
Heater	-phase/voltage [50Hz/VAC]	~1, 230	~1, 230	~2, 400	~2, 400	~2, 400
	-power consumption [kW]	2,0	2,4	3,0	5,0	6,0
	-min. air speed [m/s]	1,5	1,5	1,5	1,5	1,5
Fan	-phase/voltage [50Hz/VAC]	~1, 230	~1, 230	~1, 230	~1, 230	~1, 230
	-current [A]	0,72	0,72	0,72	0,72	0,72
	-speed [min <sup>-1</sup> ]	2621	2621	2621	2621	2621
	-power consumption [W]	164	164	164	164	164
	-max. airflow [m³/h]	675	675	675	675	675
	-motor protection class	IP-44	IP-44	IP-44	IP-44	IP-44
	Terminal box protection class	IP-54	IP-54	IP-54	IP-54	IP-54
	Filter class	G3	G3	G3	G3	G3
	Total sound pressure level at 1 m [dBA]	65	65	65	65	65
	Wiring diagram	No. 1	No. 1	No. 2	No. 2	No. 2
	41,0Weight [kg]	41,0	41,0	41,0	41,0	41,0

		250/1200	250/5000	250/6000	250/9000
Heater	-phase/voltage [50Hz/VAC]	~1, 230	~2, 400	~2, 400	~3, 400
	-power consumption [kW]	1,0	5,0	6,0	9,0
	-min. air speed [m/s]	1,5	1,5	1,5	1,5
Fan	-phase/voltage [50Hz/VAC]	~1, 230	~1, 230	~1, 230	~1, 230
	-current [A]	0,71	0,71	0,71	0,71
	-speed [min <sup>-1</sup> ]	2497	2497	2497	2497
	-power consumption [W]	160	160	160	160
	-max. airflow [m³/h]	828	828	828	828
	-motor protection class	IP-44	IP-44	IP-44	IP-44
	Terminal box protection class	IP-54	IP-54	IP-54	IP-54
	Filter class	G3	G3	G3	G3
	Total sound pressure level at 1 m [dBA]	65	65	65	65
	Wiring diagram	No. 1	No. 2	No. 2	No. 3
	Weight [kg]	51,0	51,0	51,0	51,0

### 200/6000

	Lpa dB(A)	Lwa total dB(A)	Lwa, dB(A)								
			63 Hz	125 Hz	250 Hz	500 Hz	1 kHz	2 kHz	4 kHz	8 kHz	16 kHz
Inlet	65	72	33	54	65	62	67	66	64	54	39
Outlet	64	71	33	47	66	65	65	62	56	44	29
Casing break out	49	56	20	39	48	45	49	48	47	39	25

Measured at 565 m³/h, 100 Pa

### 250/9000

	Lpa dB(A)	Lwa total dB(A)	Lwa, dB(A)								
			63 Hz	125 Hz	250 Hz	500 Hz	1 kHz	2 kHz	4 kHz	8 kHz	16 kHz
Inlet	65	72	35	53	64	61	67	67	64	55	39
Outlet	63	70	31	55	64	63	63	62	61	55	41
Casing break out	49	56	22	38	47	45	51	50	48	40	27

Measured at 666 m³/h, 130 Pa

The unit characteristic curves were determined in accordance with DIN 24163 resp. ISO 5801. The sound levels were determined in accordance with DIN 45635 resp. ISO 3744 at a distance of 1 m from the unit.

The company reserves the right to make changes of technical data without prior notice

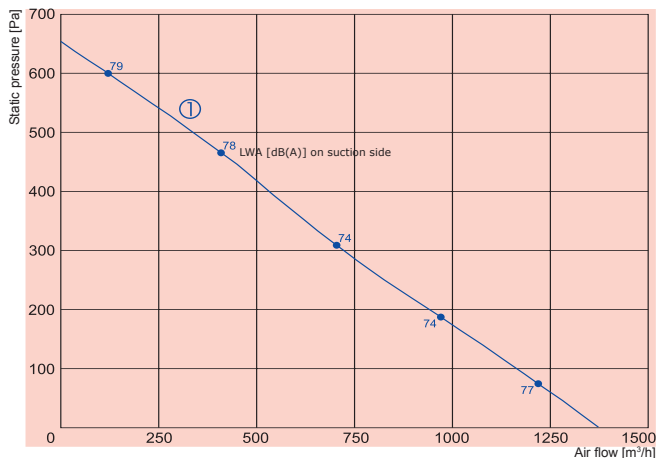

		<b>315/5000</b>	<b>315/6000</b>	<b>315/9000</b>
Heater	-phase/voltage [50Hz/VAC]	~2,400	~2,400	~3,400
	-power consumption [kW]	5,0	6,0	9,0
	-min. air speed [m/s]	1,5	1,5	1,5
Fan	-phase/voltage [50Hz/VAC]	~1,230	~1,230	~1,230
	-current [A]	1,29	1,29	1,29
	-speed [min <sup>-1</sup> ]	2343	2343	2343
	-power consumption [W]	297	297	297
	-max. airflow [m³/h]	1373	1373	1373
	-motor protection class	IP-44	IP-44	IP-44
	Terminal box protection class	IP-54	IP-54	IP-54
	Filter class	G3	G3	G3
	Total sound pressure level at 1 m [dBA]	68	68	68
	Wiring diagram	No. 2	No. 2	No. 3
	Weight [kg]	51,0	64,0	67,0

### 315/9000

	Lpa dB(A)	Lwa total dB(A)	Lwa, dB(A)								
			63 Hz	125 Hz	250 Hz	500 Hz	1 kHz	2 kHz	4 kHz	8 kHz	16 kHz
Inlet	68	75	35	54	62	62	70	72	66	60	48
Outlet	65	72	32	59	61	65	64	66	63	59	49
Casing break out	52	59	22	39	45	45	54	54	50	45	35

Measured at 1062 m³/h, 148 Pa

The unit characteristic curves were determined in accordance with DIN 24163 resp. ISO 5801. The sound levels were determined in accordance with DIN 45635 resp. ISO 3744 at a distance of 1 m from the unit.

OTA versions with electrical heater

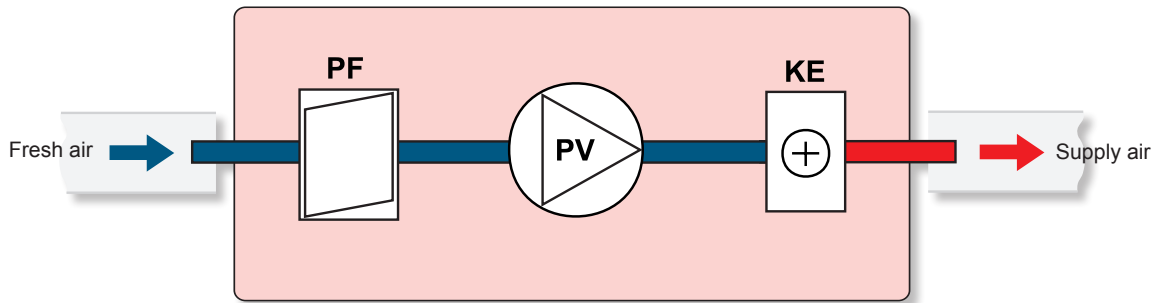

- PV - supply air fan
- KE - electrical heater
- PF - filter for supply air (class G3)

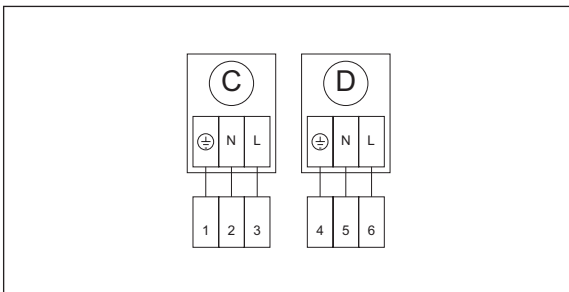

Wiring diagram No. 1

- C - Circular fan
- D - Electrical heater

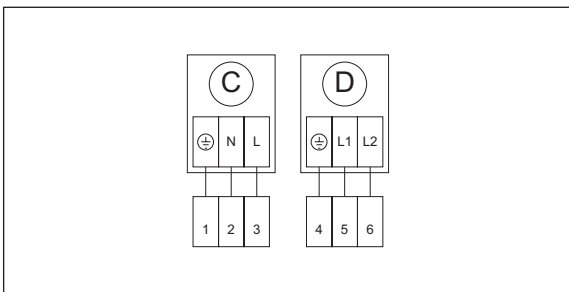

Wiring diagram No. 2

- C - Circular fan
- D - Electrical heater

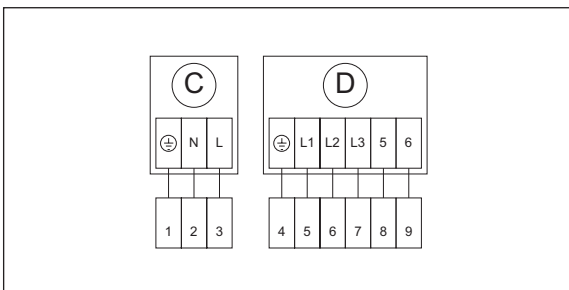

Wiring diagram No. 3

- C - Circular fan
- D - Electrical heater